



Revista Facultad de Ingeniería Universidad de Antioquia

ISSN: 0120-6230

revista.ingenieria@udea.edu.co

Universidad de Antioquia

Colombia

Armas, Octavio; Mata, Carmen; Martínez-Martínez, Simón
Effect of diesel injection parameters on instantaneous fuel delivery using a solenoidoperated injector
with different fuels

Revista Facultad de Ingeniería Universidad de Antioquia, núm. 64, septiembre, 2012, pp. 9-21

Universidad de Antioquia

Medellín, Colombia

Available in: <http://www.redalyc.org/articulo.oa?id=43025083001>

- How to cite
- Complete issue
- More information about this article
- Journal's homepage in redalyc.org

redalyc.org

Scientific Information System

Network of Scientific Journals from Latin America, the Caribbean, Spain and Portugal

Non-profit academic project, developed under the open access initiative

Effect of diesel injection parameters on instantaneous fuel delivery using a solenoid-operated injector with different fuels

Efecto de parámetros de inyección diesel sobre la entrega instantánea de combustible usando un inyector de bobina electromagnética con diferentes combustibles

*Octavio Armas^{*1}, Carmen Mata¹, Simón Martínez-Martínez²*

¹Escuela Técnica Superior de Ingenieros Industriales. Universidad de Castilla La Mancha. Edif. Politécnico, Av. Camilo José Cela s/n, 13071. Ciudad Real, Spain.

²Facultad de Ingeniería Mecánica y Eléctrica. Universidad Autónoma de Nuevo León. Monterrey, México.

(Recibido el 15 de agosto de 2012. Aceptado 27 de agosto del 2012)

Abstract

This work describes an experimental setup for obtaining pressure variation and rate of injection profiles per engine stroke. This study focuses on the following experimental parameters: flow meter's backpressure, injection pressure, and duration of the process. An IAV EVI-2-type flow meter is used to measure the rate of injection. The work has been carried out using a common rail system with a solenoid-operated injector. As result, time profiles of: current intensity throughout the injector (electric pulse), pressure variation in flow meter (Δp) and the rate of injection are presented. The study has been carried out with four different fuels: a diesel fuel without biodiesel, a diesel fuel with 5.83% of biodiesel, a biodiesel fuel derived from animal fats and a synthetic diesel fuel derived from a Fischer Tropsch process at low temperature. The experimental set up and the established procedures have proven to be adequate for studies with current diesel injection systems. The differences registered in rate of injection have been mainly caused by the differences in density of fuels studied.

----- **Keywords:** Diesel injection, common rail, rate of injection, solenoid-operated injector

* Autor de correspondencia: teléfono: 34 + 926 + 295 300 ext. 3825, fax: + 34 926 + 295 462, correo electrónico: octavio.armas@uclm.es (O. Armas)

Resumen

Este trabajo describe la instalación experimental para obtener los perfiles temporales de variación de presión y de la tasa de inyección de combustible por ciclo termodinámico. Los parámetros estudiados han sido los siguientes: la contrapresión en el caudalímetro, la presión de inyección y la duración del proceso. En el trabajo se usó un medidor de tasa de inyección del tipo IAV EVI-2. El trabajo se realizó utilizando un sistema de inyección del tipo common rail con un inyector de bobina electromagnética. Como resultado, se presentan los perfiles temporales de la intensidad de corriente a través del inyector (pulso eléctrico), la variación de presión en el medidor de caudal (Δp) y la tasa de inyección. El estudio se ha realizado con cuatro combustibles diferentes: un combustible diesel sin biodiesel, un combustible diesel con 5.83% de biodiesel, un biodiesel de grasas animales y un diesel sintético derivado de proceso Fischer Tropsch de baja temperatura. La instalación experimental y los procedimientos establecidos han demostrado ser adecuados para estudios de los actuales sistemas de inyección. Las diferencias registradas en términos de tasa de inyección han sido fundamentalmente debidas a las diferencias en densidad de los combustibles estudiados.

----- **Palabras claves:** Inyección diesel, common rail, tasa de inyección, inyector de bobina electromagnética

Notation

a	<i>Speed of sound</i>
A_t	<i>Cross sectional area</i>
BAF	<i>Biodiesel from Animal Fats</i>
CFPP	<i>Cold Filter Plugging Point</i>
CRP	<i>Common Rail injection Pressure</i>
DA	<i>Diesel fuel denoted as A</i>
DB	<i>Diesel fuel denoted as B</i>
$\Delta p(t)$	<i>Pressure increase</i>
ET	<i>Energizing time</i>
FAME	<i>Fatty Acid Methyl Esther</i>
FTLT	<i>Fischer Tropsch at Low Temperature</i>
$m_f(t)$	<i>Fuel mass flow rate</i>
P_{back}	<i>Back pressure</i>

from the combination of different parameter such as: nozzle diameter, injection pressure, injection duration, number of injections and also some fuel properties such as: density, viscosity and bulk modulus, which characterizes the compressibility of fuels. [1, 2].

The rate of injection directly affects the evolution of the diesel spray and its interaction with the in-cylinder air, it conditioning this way the evolution of the combustion process. The rate of injection has direct influence on derived performance, pollutant emissions and combustion noise.

Given these premises is easy to understand the need to study the formation of the diesel spray. Currently, there are a large number of works related to the knowledge of the parameters characterizing the jet diesel [3 - 6] and its interaction with the air in the combustion chamber. [7, 8]. These studies have been mainly focused on the improvement of the air-fuel mixture formation throughout the development of injectors [9, 10] or studying the effect of fuels on both the injection and combustion processes [11-13].

Introduction

Knowledge of the rate of injection during a thermodynamic cycle is essential due to it is an important information as control parameter of air-fuel mixture formation and combustion processes in a diesel engine. The rate of injection is derived

Moreover, knowledge of the rate of injection is important in solving the problem related to the calculation of heat released of diesel combustion by solving zero dimensional thermodynamic models. In the solution of the first law of thermodynamics for open systems (equation basis of such models), the rate of injection is an input parameter which affects the determination of the in-cylinder charge composition during both the compression and combustion processes [14, 15].

Finally, the rate of injection may be a control parameter of the functionality of the whole Diesel injection system and, particularly, of the injection nozzles after long working periods either during the actual life of an engine or vehicle, or during studies of durability, specially designed to determine, for example, the effect of fuels [16, 17].

The importance of diesel rate of injection has motivated the development of this work, where, after evaluating different methods and commercial equipment for determining the rate of injection, it was decided to use the method commonly known as Bosch method [18 - 20] due to its advantages and easy operation. This paper presents the integration and configuration of a system, its procedures and results to determine the rate of injection when modifying different injection parameters with different alternative fuels.

One of the most complete works done related to the effect of fuel properties on parameters of fuel injection process has been presented by J. Dernote *et al* [21]. In this work a description of a similar installation has been done. However, some details were not presented such as a more detailed configuration of the installation, main

operating parameters and a better presentation of fuels used during the work. Desantes *et al.* [22] compared diesel and biodiesel fuels in a conical orifice for a variation of pressure difference between injection pressure and back-pressure from 15 to 40 MPa. They concluded that density is the unique property driving the mass flow rate and the effective velocity. Viscosity only impacts the opening and closing of the injector.

In the present work, a preliminary study about the effect of the main injection parameters using different alternative fuels has been carried out. Although the ranges of both the back and the injection pressures were different, similar results to those obtained by Desantes *et al* were obtained.

Experimental work

Test fuels

As test fuels were used the following: two commercial diesel fuels denoted as Diesel 1 and 2. Both fuels comply the EN590 standard. Diesel fuel, denoted as DA, was supplied by CEPESA Co. while the Diesel fuel, denoted as DB, was supplied by REPSOL Co. As one of alternative fuels, a commercial synthetic fuel, derived from natural gas, commonly known as gas-to-liquid and derived from a low temperature Fischer Tropsch process, was used. This fuel was supplied by SASOL Co and was denoted as FTLT. Finally, as second alternative fuel one biodiesel, derived from animal fats, completes the fuel matrix. This biodiesel fuel was supplied by Stock del Vallés BDP Co and was denoted as BAF. Main properties of fuels used and related to fluid-dynamic are presented in table 1.

Table 1 Fuel properties

<i>Property</i>	<i>Method</i>	<i>DA</i>	<i>DB</i>	<i>BAF</i>	<i>FTLT</i>
Distillation (°C)					
65%	ASTM D-86	303.5	255.5	322	276
85%		336	270.5	331	318
95%		357	286.5	-	354
Density 15°C (kg/m ³)	EN ISO 12185	845	813	877	774

Property	Method	DA	DB	BAF	FTLT
CFPP (°C)	UNE-EN 116-98	-16	-32	3	-7
Kinematic viscosity 40°C (cSt)	UNE-EN-ISO 3104-96	2.768	2.015	4.033	2.57
Lubricity (µm)	UNE-EN ISO 12156-1-07	348	334	193	353
Sulphur (ppm)	ASTM D-2622	20	3.1	32	1
Water (mg/kg)		70	89	124	-
Cetane number	ASTM D-613/08	49.6	65.36	54.51	>73
FAME content (% v/v)	UNE-EN 14078-10	5.8	0	100	0

Experimental installation

Figure 1 shows a simplified diagram of the entire facility used for the tests for determining the rate of injection or fuel delivery.

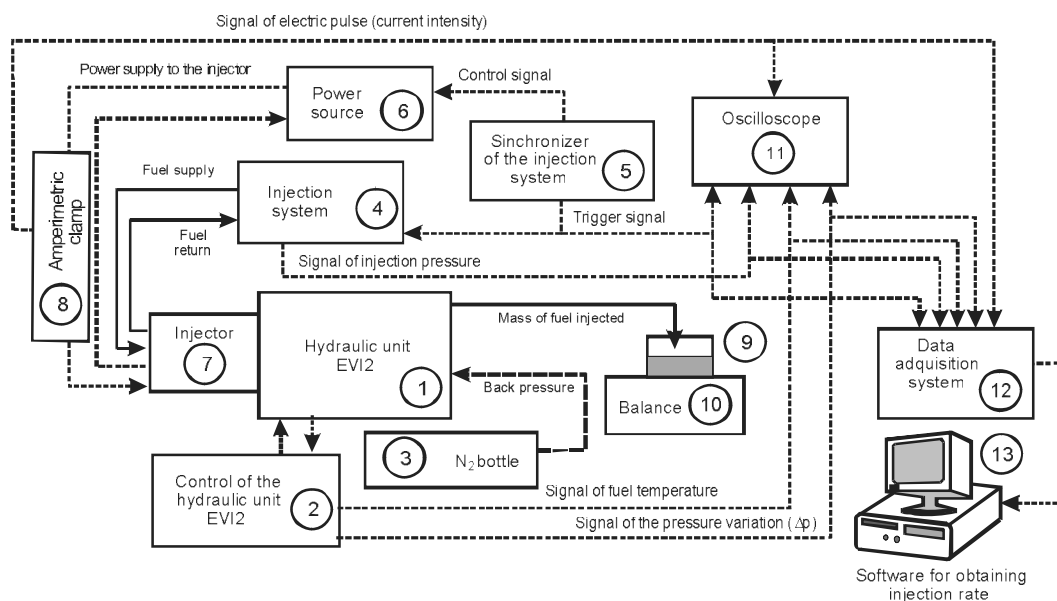

Figure 1 Sketch of the experimental installation

The experimental installation is essentially composed of the hydraulic unit EVI K-50-49 (1), manufactured by BTI company, the control box (2) and a nitrogen cylinder (3) to secure the desired back pressure in (1). However, for a correct operation of the entire system the integration of other components is needed: the fuel injection system independently controlled (4), which is composed of: the frequency converter-electric motor-high pressure pump setting, the

heat exchanger for cooling the fuel, common rail injection system, fuel tank and pressure and temperature sensors. The synchronizer of the injection system (5) includes the frequency generator, trigger and pressure regulator in the common rail. The power amplifier (6) which supply energy to the fuel injector (7), this last one driven by an inductive system (solenoid) with injection nozzle type VCO, with 5 holes, 0.284 mm in diameter and manufactured by Bosch.

Parts (4), (5) and (6) form equipment, which was designed and built at the Institute of Thermal Engines CMT of the Technical University of Valencia. The signal intensity of the electrical pulse is measured with an current probe model LEM HEME PR 1030 (8). The fuel injected into the hydraulic unit finishes collecting in the container (9) and weighed on an analytical balance Kern, PCB 4000 (10). Time signals derived from (2), (5) and (8) are visualized and checked by an oscilloscope Tektronix TDS 410 (11) and finally recorded in a data acquisition system Yokogawa OR1400 (12). The recorded data are processed with a Matlab code to calculate the instantaneous fuel delivery [17].

The operation of the hydraulic unit (1) is based on the method proposed by Bosch, based on anechoic tube, where the fuel mass flow is determined by measuring of the pressure increase generated by the fuel injection inside a tube of specific diameter and length, which contains the same type of fuel, which is injected at a given pressure. Delivery of

fuel is obtained by solving the equation 1. The method is described in detail in [19, 20].

$$m_f(t) = \frac{A_t \cdot \Delta p(t)}{a} \quad (1)$$

Where $m_f(t)$ is the fuel mass flow rate (kg/s), A_t is the cross sectional area of the (m^2), $\Delta p(t)$ is the pressure increase over the pressure inside the volume of the hydraulic unit (Pa). The last one it is known as back pressure. a is the speed of sound in the fuel contained in the volume of the hydraulic unit (m/s).

Figure 2 shows the cross section of the hydraulic unit. On it is indicated the internal zones: at the right hand, the volume for fuel and, at the left hand, volume for nitrogen gas. Both separated by a piston. It also shows the position of the nozzle, the nitrogen inlet and fuel outlet. Table 2 presents the main operating parameters of the installation configured.

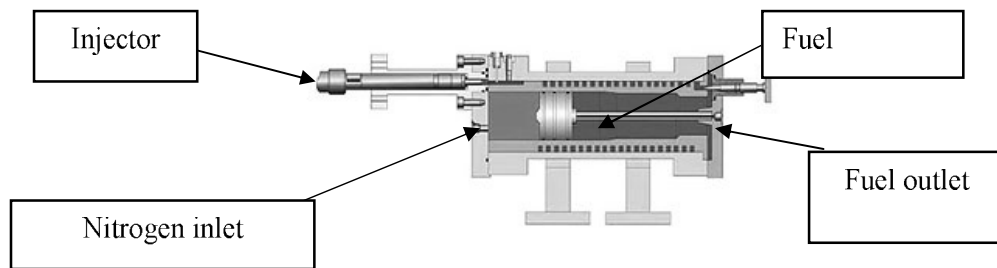

Figure 2 Sketch of the hydraulic unit sectioned

Table 2 Ranges and accuracy of main operating parameters of the installation

<i>Parameter or equipment</i>	<i>Unit</i>	<i>Operating range</i>	<i>Accuracy [% of reading]</i>
Injection pressure	MPa	200.....1300	± 0.1
Back pressure	MPa	1.....18	± 0.1
Energizing time	µs	80.....9999	± 0.05
Number of injections	-	9	-
Frequency generator	MHz	0.01.....10	± 0.05
Current probe	A	± 140	± 1% in ± 100 mA
Temperatures	°C	± 70	± 0.05
Balance	g	0.....4000	± 0.025

Procedure

In order to ensure the quality of measurements, tests were performed with a previous preheating of the installation and fuel temperature at the inlet of the high pressure pump was kept around $18 \pm 2^\circ\text{C}$. Tests without preheating can modify the delivery of fuel due to the change of the sections, by dilatation, which would vary the flow of fuel through the return of the injector. The value of pressure in the hydraulic unit was kept constant at 7.2 MPa. Although, the backpressure in this equipment can be regulated up to 18 MPa, the pressure chosen coincides with the final compression pressure in the cylinder of a diesel

engine with an intake pressure of 0.175 MPa, a compression ratio of 15.78 and a mean polytropic coefficient of compression equal to 1.35. The values of fuel delivery (rate of injection) presented are derived from the arithmetic mean of three trials in each operating mode.

Tests plan

In order to check the quality of the experimental facility, the feasibility of the proposed experimental procedures and measurements, a study of repeatability of the rate of injection curves (mass flow rate) and intensity of the electric pulse to the injector profiles in each test is proposed in table 3.

Table 3 Test plan for repeatability study

<i>Injection</i>	<i>ET pilot (µs)*</i>	<i>Dwell time (µs)**</i>	<i>ET main (µs)</i>	<i>CRP (MPa)</i>	<i>P_{back} (MPa)</i>
Single	-	-	1600	105	7.2
Split	170	2222	1700	90	

*ET – Time of energizing during injections (pilot or main) **Dwell time – time between injections

For determining the effect of the back pressure in hydraulic unit (P_{back}) on Δp profiles, the test plan presented in table 4 was followed.

Table 4 Test plan for studying the effect of P_{back} at different CRP

<i>Injection</i>	<i>P_{back} (MPa)</i>	<i>ET (µs)</i>	<i>CRP (MPa)</i>
Single	6.2	1700	75
	7.2		90
	8.2		105

With the objective to determine the mass flow rate profiles (rate of injection) with each fuel, for different times of energizing (ET) and common rail pressures (CRP), the test plans presented in tables 5 and 6 were carried out. This part of the work was carried out only with single injection.

Table 5 Test plan for studying the effect common rail injection pressure (CRP)

<i>Injection</i>	<i>ET (µs)</i>	<i>CRP (MPa)</i>	<i>P_{back} (MPa)</i>
Single	1600	90	7.2
		105	
		120	

Table 6 Test plan for studying the effect of energizing time (ET)

<i>Injection</i>	<i>CRP (MPa)</i>	<i>ET (µs)</i>	<i>P_{back} (MPa)</i>
Single	90	1400	7.2
		1600	
		1700	
		1800	
		1900	

Results and discussion

Repeatability

According to the results presented in figures 3, 4 and 5, it can be concluded that the experimental installation set and the procedure defined, made possible to obtain an adequate repeatability of the rate of injection curves in time (figures 3 and 4), as well as in mass injected during each test (figure 5). In all cases error bars with 90% confidence have been added.

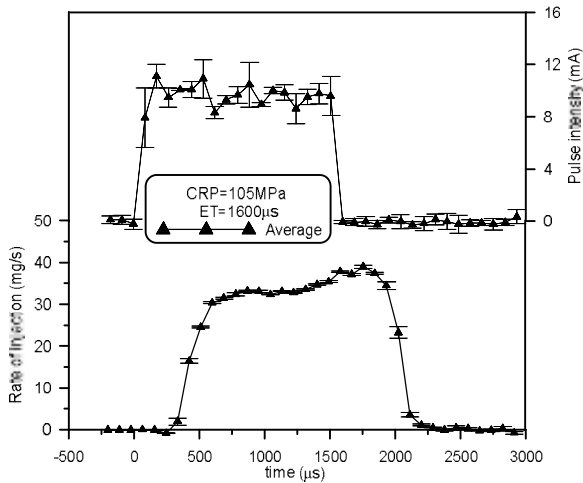

Figure 3 Repeatability of pulse intensity and rate of injection profiles. Single injection.

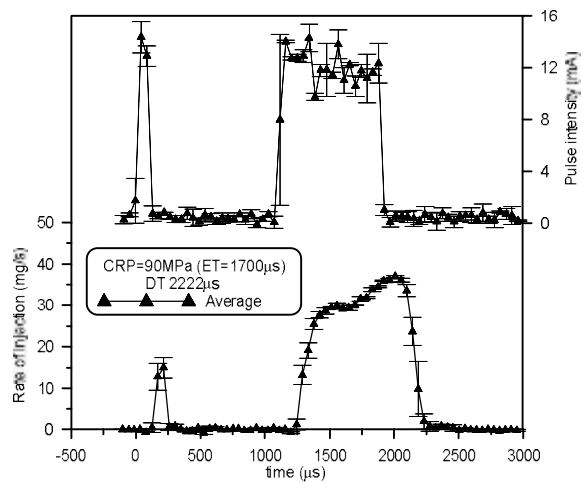

Figure 4 Repeatability of pulse intensity and rate of injection profiles. Split Injection.

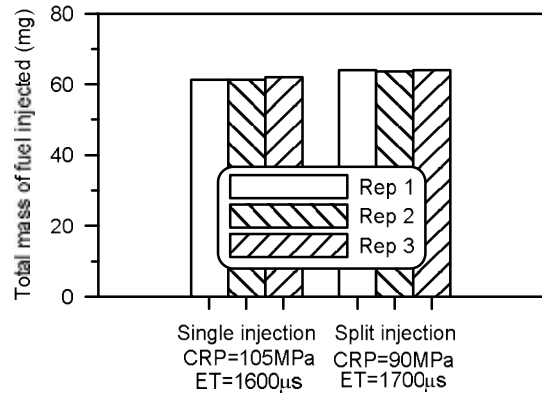

Figure 5 Total fuel mass injected in each repetition with each type of injection

In addition, as can be seen, there is a time lag between the beginning of the energizing time and the beginning of the rate of injection. This known behaviour is due to the mechanical and hydraulic delays of the needle lift. A similar effect, although more significant, appears between the end of the energizing time and the end of the rate of injection. The knowledge of this time lag is necessary for synchronization of the rate of injection with the rate of heat release results during thermodynamic diagnosis. Normally, during the engine tests, pulse intensity throughout the injector is measured and the rate of injection is obtained in a test bench similar to this described in this work.

Effect of the back pressure on Δp profiles

Figure 6 shows the effect of the back pressure on Δp profiles with different common rail pressures (CRP) during a time of energizing equal 1.7 ms.

While there are works where the rate of injection studies are performed with values of the back pressure relatively low (3-5 MPa) [1, 10], this paper studies the effect of this parameter using values close to that would be achieved in the cylinder of an engine in real operating conditions. In this case, the pressure at the end of the compression process of the hypothetical engine was 7.2 MPa corresponding to 0.175 MPa of intake pressure.

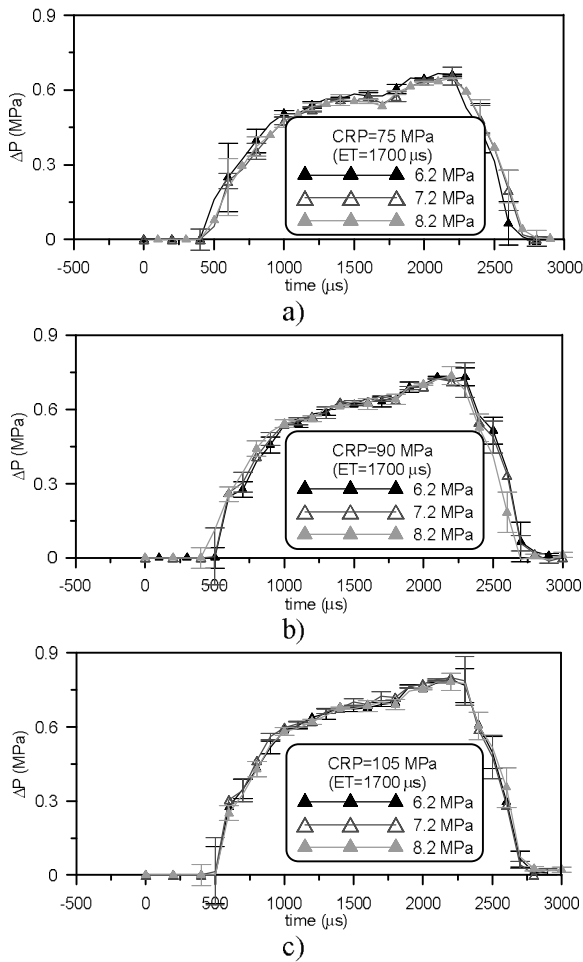

Figure 6 Effect of the back pressure on Δp profiles. a) CRP = 75 MPa, b) CRP = 90 MPa, c) 105 MPa

Results show that changes in back pressure, in the range of $7.2 \text{ MPa} \pm 15\%$, produced no significant differences over the curves of Δp . This result indicates that the study of the effect of injection parameters can be performed remaining the back pressure in $\pm 1 \text{ MPa}$ around the value used for simulating the final compression pressure during an actual injection process in an diesel engine.

Effect of the CRP on pulse intensity and on rate of injection profiles with different fuels

As control parameter of the tests, figures 7, 8, 9 and 10 show the coincidence at the initial and final instants of the energizing time varying the CRP with each fuel. Independently of the fuel used the area under the rate injection profiles increased in correspondence with the CRP increase.

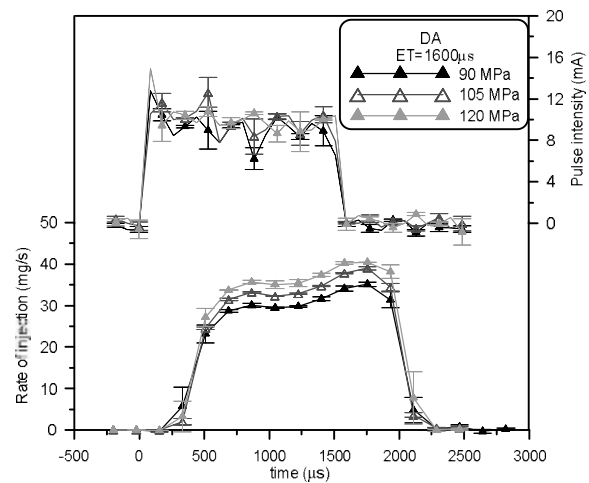

Figure 7 Effect of the CRP on both the pulse intensity and the rate of injection profiles using DA fuel

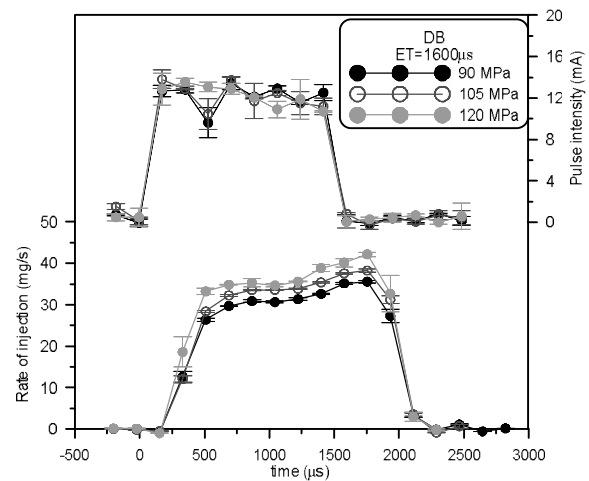

Figure 8 Effect of the CRP on both the pulse intensity and the rate of injection profiles using DB fuel

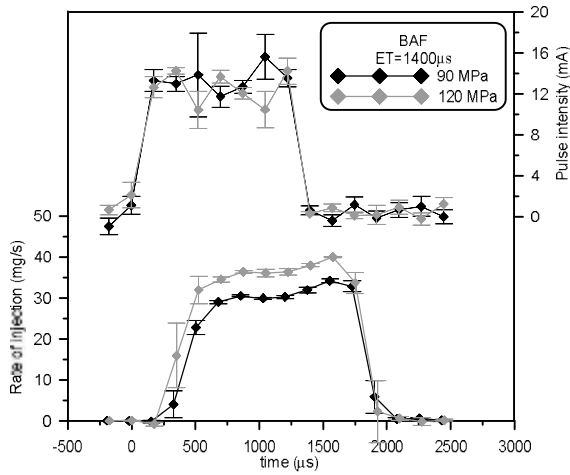

Figure 9 Effect of the CRP on both the pulse intensity and the rate of injection profiles using BAF fuel

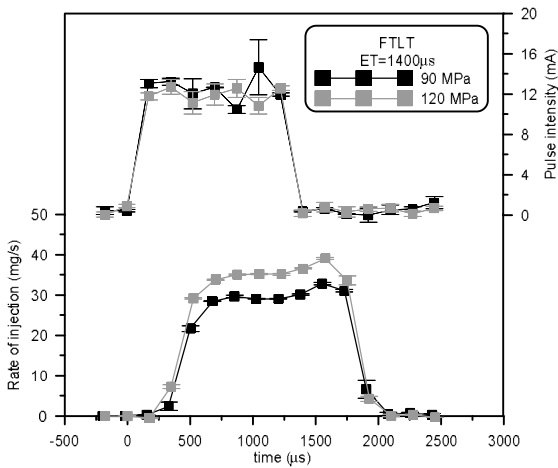

Figure 10 Effect of the CRP on both the pulse intensity and the rate of injection profiles using FTLT fuel

However, in all cases (in figures 7-10), the rates of injection increased less at the first instants of the injection process than at the final ones. This behaviour can be explained, because, although the common rail tries to remain constant the CRP, it decreases initially due to the pressure drop produced by the opening of the injector [23]. This effect occurred independently of the fuel used.

As figure 11 shows total mass of fuel injected is proportional to the common rail pressure, the higher the injection pressure the greater the total mass injected. Comparing both diesel fuels (see figure 11 left), a slight increase in total mass injected with DB was observed. According to the fuel properties, presented in table 1 (density and viscosity), the results seem to be inconsistent. However, this behaviour can be explained by the differences in fuel temperature at the inlet of the high pressure pump registered with both fuels during respective tests. Although figure 11 right, shows only results at 90 and 105 MPa of CRP, results are consistent with density and temperature of the tests.

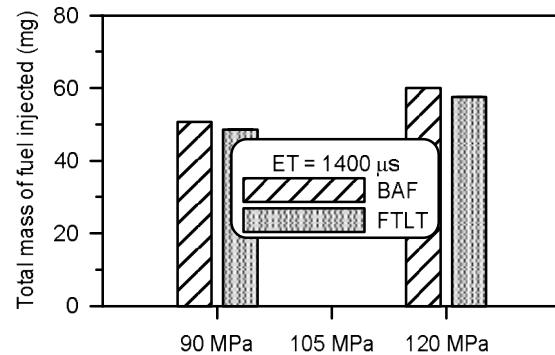
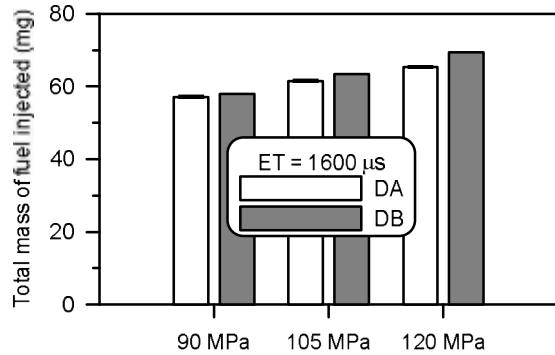

Figure 11 Effect of the CRP on the total mass of fuel injected. Mean values.

Figure 12 shows, as example for CRP = 90 MPa, that fuel temperature of DB was slightly lower than the temperature of DA fuel. In these cases, probably the higher fuel viscosity of DA is also contributing to the lower fuel mass injected.

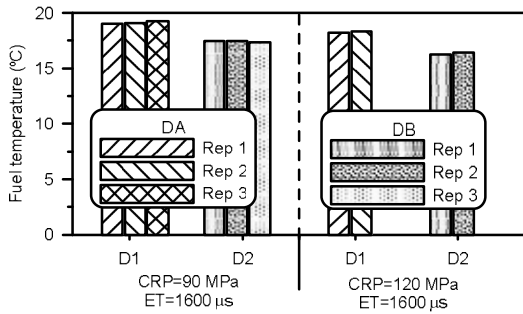

Figure 12 Fuel temperatures at the inlet of the high pressure pump during tests with diesel fuels. CRP = 90 and 120 MPa, ET = 1600 µs

Results presented in figure 13 shows fuel temperatures for each repetition. These results would explain the differences in total mass injected presented in figure 11 left. These are due to the differences in density and, in addition, due to the differences in fuel temperature, which are affecting in the same sense.

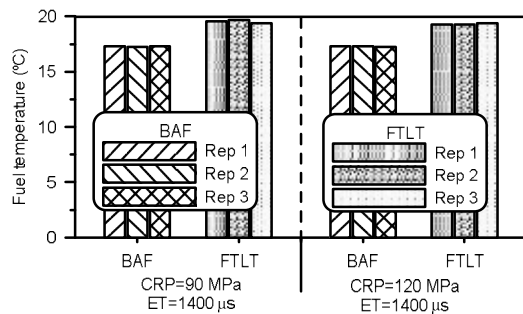

Figure 13 Fuel temperatures at the inlet of the high pressure pump during tests with BAF and FTLT fuels. CRP = 90 and 120 MPa, ET = 1400 µs.

Effect of the ET on both the pulse intensity and the rate of injection profiles with different fuels

Figures 14, 15, 16 and 17 show the pulse intensity and rate of injection profiles varying the duration of energizing time of the injector with each fuel. Pulse intensity profiles show a good coincidence at the beginning of the rate of the injection. At the end of injection process, the final instant of the injection increased in correspondence with the increase of the energizing time.

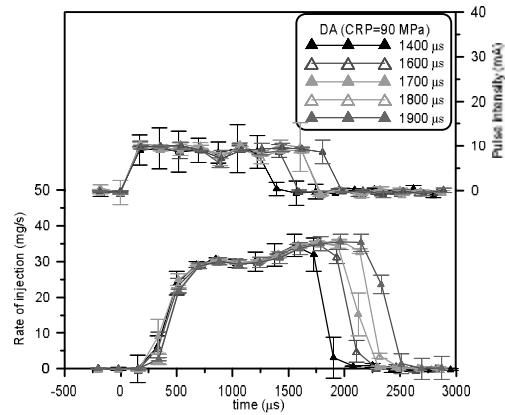

Figure 14 Effect of the ET on both the pulse intensity and the rate of injection profiles using DA fuel

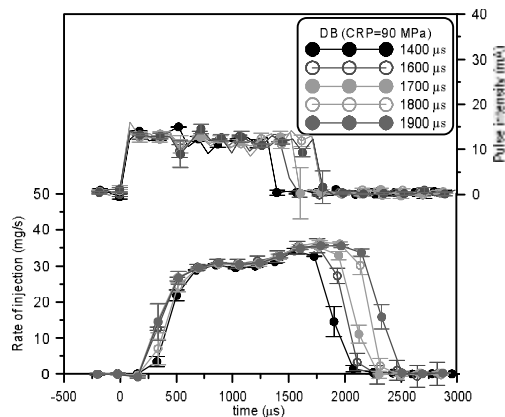

Figure 15 Effect of the ET on both the pulse intensity and the rate of injection profiles using DB fuel

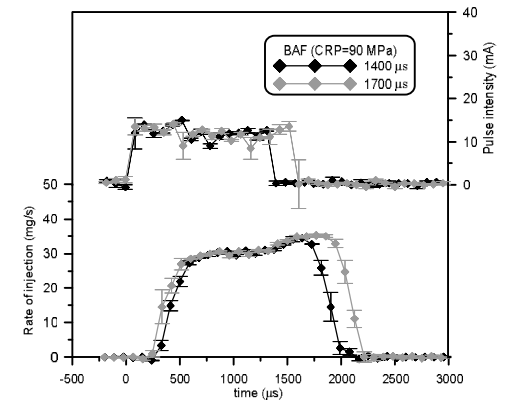

Figure 16 Effect of the ET on both the pulse intensity and the rate of injection profiles using BAF fuel

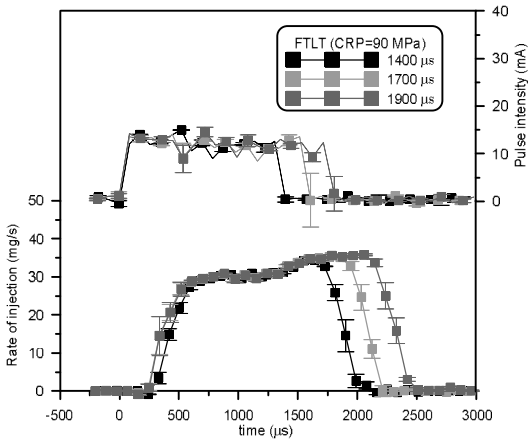

Figure 17 Effect of the ET on both the pulse intensity and the rate of injection profiles using FTLT fuel

Pulse intensity profiles show a good coincidence at the beginning of the energizing time. The end of the profiles is scaled in correspondence of the pulse duration. Similar behaviour is seen with the rate of injection profiles. For example, in figure 14 the difference in energizing time between the first two tests is 200 μs . However, between the rest of the tests is only 100 μs . The experimental method has enough sensitivity to detect this type of changes.

Figure 18 clearly shows the correspondence between the total mass of fuel injected and the increase of energizing time, and, in consequence, with the duration of the injection.

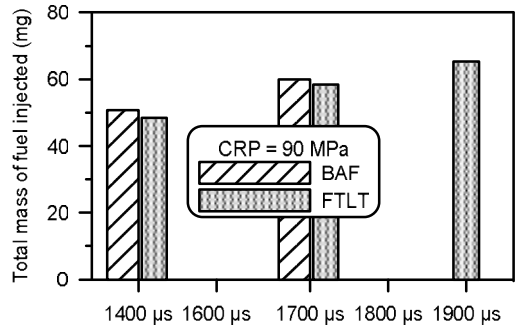
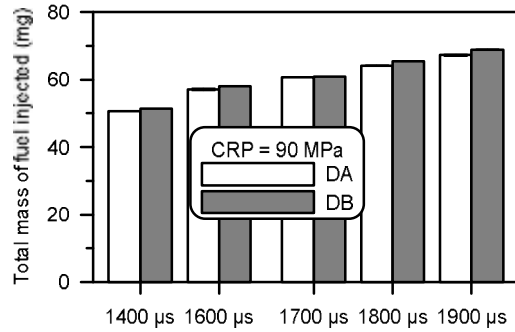

Figure 18 Effect of the energizing time of the injector on the total mass of fuel injected. Mean values.

In figure 18 left, again the differences in total mass of fuel injected can be explained by the slight differences in fuel temperature as figure 19 shows.

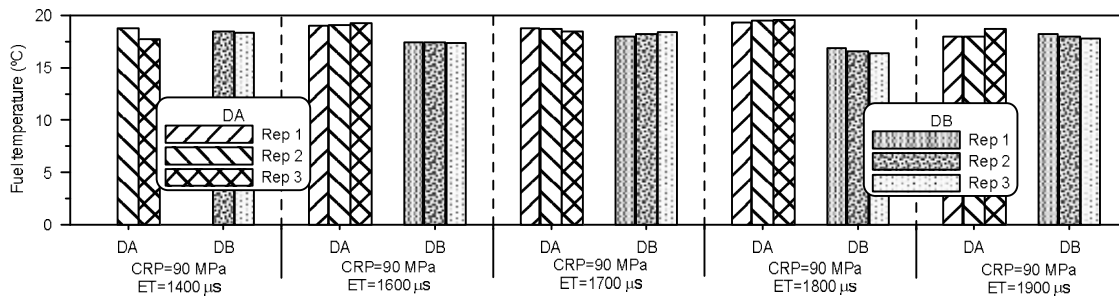

Figure 19 Fuel temperatures at the inlet of the high pressure pump during tests with diesel fuels. CRP = 90 MPa and different ET

Conclusions

This work summarized all the equipment and procedures of an installation for determining the rate of injection using a common rail injection system with a solenoid-operated injector. This installation can also be used with other types of injectors such as piezoelectric.

From the experimental study some conclusions can be enounced:

- a) Results from both modes of injection (single and split), demonstrates that the repeatability of the installation is adequate.
- b) The range of the back pressure tested does not produce any significant effect on the rate of injection. This makes it possible to carry out tests without modification of this parameter, which allows a considerable time saving of the test characterization.
- c) The total mass of fuel injected corresponded with the variation of the parameters studied (common rail pressure and energizing time of the injector) and with the density of fuel used. As higher the density, injection pressure and energizing time as greater the total fuel mass injected.
- d) Fuel temperature at the inlet of the high pressure fuel pump should be remained within an interval narrower than ± 2 °C.

Acknowledgement

Authors wish to thank the financial support to: a) the project COMBALT2 Ref. POII10-0173-0731 provided by the Castilla La Mancha government and b) the stay of Prof. Simón Martínez-Martínez provided by the University of Castilla La Mancha. Authors also wish to thanks companies which supplied fuels: SASOL by the FTLT fuel, REPSOL by the DB fuel and BNP Stock del Vallés by the BAF fuel.

References

1. R. Payri, F. Salvador, J. Gimeno, G. Bracho. The effect of temperature and pressure on thermodynamic properties of diesel and biodiesel Fuels. *Fuel*. Vol. 90. 2011. pp. 1172-1180.
2. M. Lapuerta, J. Agudelo, M. Prorok, A. Boehman, L. Bulk. Modulus of Compressibility of Diesel/Biodiesel/HVO Blends. *Energy Fuels*. Vol. 26. 2012. pp. 1336-1343.
3. J. Desantes, R. Payri, F. Salvador, J. Gimeno. *Different measurement techniques to determine hole to hole dispersion in a real diesel injector. FEDSM2006-98212*. Proceedings of FEDSM2006 2006 ASME Joint U.S. - European Fluids Engineering Summer Meeting, July 17-20. Miami, FL. 2006.
4. R. Payri, S. Ruiz, F. Salvador, J. Gimeno. "On the Dependence of Spray Momentum Flux in Spray Penetration: Momentum Flux Packets Penetration Model". *Journal of Mechanical Science and Technology*, Vol. 21. 2007. pp. 693-698.
5. V. Bermúdez, J. García, E. Juliá, S. Martínez. Engine with Optically Accessible Cylinder Head: a Research Tool for Injection and Combustion Processes. *SAE paper* 2003-01-1110. 2003.
6. J. Agudelo, A. Agudelo, P. Benjumea. "Study of diesel sprays using computational fluid dynamics". *Rev. Fac. Ing. Univ. Antioquia* N.º 49. 2009. pp. 61-69.
7. J. Desantes, J. Arrègle, J. López, "Scaling laws for free turbulent gas jets and diesel-like sprays". *Atomization and Sprays*. Vol. 16. 2006. pp. 443-473.
8. J. Desantes, J. Arrègle, J. López, J. García. "A contribution to the study of a diesel spray interacting with a cross flow". *Atomization and Sprays*, Vol. 16. 2006. pp. 511-530.
9. R. Payri, F. Salvador, P. Martí, J. Martínez. "Using one-dimensional modeling to analyze the influence of the use of biodiesels on the dynamic behavior of solenoid-operated injectors in common rail systems: Detailed injection system model". *Energy Conversion and Management*. Vol. 54. 2012. pp. 90-99.
10. J. Desantes, R. Payri, F. Salvador, A. Gil. "Development and validation of a theoretical model for diesel spray penetration". *Fuel*. Vol. 85. 2006. pp. 910-917.
11. J. Szybist, D. Morris, A. Boehman. "Diesel fuel formulation effects on injection timing and emissions". *Fuel Chem Div Prepr*. Vol. 16. 2002. pp. 47(1).

12. M. Lapuerta, O. Armas, R. Ballesteros, J. Fernández. "Diesel emissions from biofuels derived from Spanish potential vegetable oils". *Fuel*. Vol. 84. 2005. pp. 773-780.
13. J. Luján, B. Tormos, F. Salvador, K. Gargar. "Comparative analysis of a DI diesel engine fuelled with biodiesel blends during the European MVEG-A cycle: Preliminary study (I)". *Biomass and bioenergy*. Vol. 33. 2009. pp. 941-947.
14. M. Lapuerta, O. Armas, J. Hernández. "Diagnosis of DI Diesel combustion from in-cylinder pressure signal by estimation of mean thermodynamic properties of the gas". *Applied Thermal Engineering*. Vol. 19. 1999. pp. 513-529.
15. F. Payri, S. Molina, J. Martín, O. Armas. "Influence of measurement errors and estimated parameters on combustion diagnosis". *Applied Thermal Engineering*. Vol. 26. 2006. pp. 226-236.
16. O. Armas, C. Mata, S. Martínez. "Effect of an ethanol-biodiesel-diesel blend on the durability of a common rail injection system". *Fuel Processing Technology*. Vol. 92. 2011. pp. 2145-2153.
17. O. Armas, C. Mata, S. Martínez. "Effect of an ethanol-diesel blend on a common-rail injection system". *Institution of Mechanical Engineers. International Journal of Engine Research*. Vol. 3. 2012. pp. 417-428.
18. R. Payri, F. Salvador, J. Gimeno, G. Bracho. "A new methodology for correcting the signal cumulative phenomenon on rate of injection measurements". *Experimental techniques*. Vol. 32. 2008. pp. 46-49.
19. W. Bosch. *The Fuel Rate Indicator: A New Measuring Instrument for Display of the Characteristics of Individual Injection*. SAE paper 660749, SAE International, Warrendale, PA. DOI: 10.4271/660749. 1966.
20. R. Lillington. A Review of Heavy Duty Diesel Injector Characterization. Disponible en: http://www2.warwick.ac.uk/fac/sci/eng/pg/students/esrjar/research/redacted_15-6-11_a_review_of_the_existing_literature_on_injector_valve_transfer_function_and_performance_analysis.pdf. Consultada el 15 de junio de 2011.
21. J. Demotte, C. Hespel, F. Foucher, S. Houillé, C. Mounaïm. "Influence of physical fuel properties on the injection rate in a Diesel injector". *Fuel*. Vol. 96. 2012. pp. 153-160.
22. J. Desantes, R. Payri, A. Garcia, J. Manin. "Experimental study of biodiesel blends effects on diesel injection processes". *Energy Fuels*. Vol. 23. 2009. pp. 3227-3235.
23. F. Payri, J. Desantes (editores). *Motores de Combustión Interna Alternativos*. Editorial Reverté. ISBN 978-84291-4802-2. 1ª ed. Valencia. España. Capítulo 19. 2011. pp 579-618.